

SP100 Series

Solar Pump Controller



About us



Company Introduction

INVT (Shenzhen INVT Electric Co., Ltd) has been concentrating on industry automation and energy power since its foundation in 2002 and is committed to "Providing the best product and service to allow customers more competitiveness". INVT goes public in 2010 and is the first A-share listed company (002334) in Shenzhen Stock Exchange in the industry. At present, INVT owns 15 subsidiaries and more than 4500 employees, over 40 branches, forming a sales network covering more than 100 overseas countries and regions.

INVT has been awarded as the Key High-tech Enterprise of National Torch Plan based on mastering of key technologies in power electronics, auto control and IT. With business covering industry automation, electric vehicle, network power and rail transit, INVT has established 10 R&D centers nationwide, boasts more than 1400 patents and owns the first lab in the industry awarded ACT qualification from TÜV SÜD, UL-WTDP and CNAS National Lab. The industrial parks in Shenzhen and Suzhou aim to provide customers with advanced integrated product development design management, comprehensive product R&D test and auto informational production. The worldwide INVT branches and warranty service centers are ready to offer customers all-around back-ups including professional solutions, technical trainings and service support.

In the next decade, INVT will continue to take " Sincere Virtuous, Professional Aspiring" as our business philosophy, enhance core business sectors including industrial automation, electric vehicle, network power and rail transit based on the three major technologies in industry automation and energy power fields, and strive to become a leading, responsible and harmonic international professional group armed with proper product structure, leading technologies, efficient management, robust profitability and superior competitiveness.





Social friendly, green and low-carbon



Stable quality and excellent performance



Strong power and adaptable



Save your money, time and effort



Smart and flexible configuration

Model Introduction

Features: High ingress protection degree; high integration; high reliability

Advantages: Simpler system

Benefit: Easy installation and lower cost



SP100(DC)

Only PV input

- IP66 High protection level, outdoor installation
- Integrated DC breaker
- Integrated Fuse
- Integrated surge protection
- Multi pump protection
- Automatic run and stop
- LCD display
- Support 4G and WIFI for monitoring



SP100(AC&DC)

Support hybrid operation

- Same as SP100(DC)
- Support the connection of grid and diesel generator
- Automatic hybrid compensation
- Built-in anti-reverse diode
- AC, DC energy consumption display
- Below 4kw built-in booster(include 4kW)

System Diagram

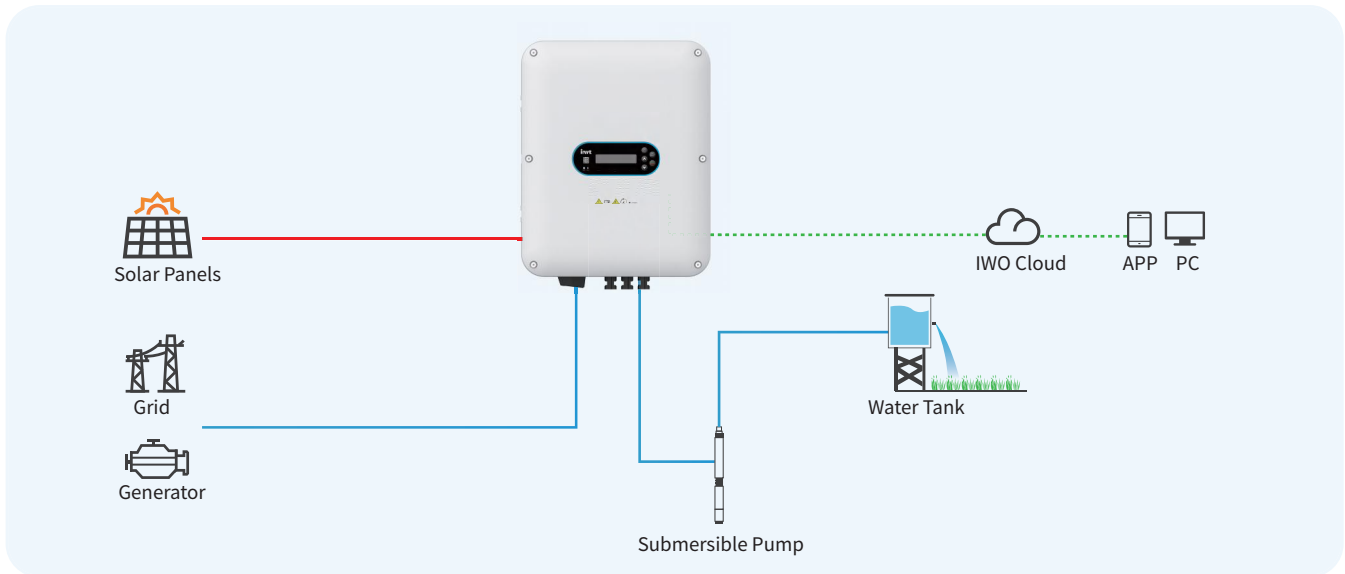

Model Name

SP100-004-4-T-6-S

Product series SP100: SP100 series solar pump controller

Power range 004: 4kW

Voltage class

4-T: AC 3PH 380V(-15%)-440V(+10%); DC 220V-900V
 2-T: AC 1PH/3PH 220V(-15%)~240V(+10%); DC 100V~450V
 D4: DC 250V-900V
 D2: DC 150V-450V
 4: AC 3PH 380V(-15%)-440V(+10%); DC 250V-900V
 2: AC 1PH/3PH 220V(-15%)~240V(+10%); DC 150V~450V

Boost module Empty: No built-in boost module T: With built-in boost module

Ingress protection (IP) 0: IP00 6: IP66

Product configuration S: Standard

Application

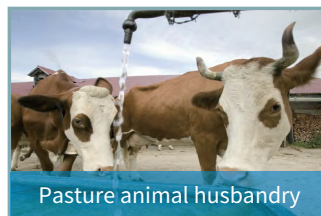



Features

High Integration

- Replace the combiner box: SP100 integrates DC breaker, Fuse, SPD and Bus-bar, and with its IP66 ingress protection degree, SP100 don't need combiner box, which makes system simpler.

SP100 can simplify the solar pump system



SP100

VS

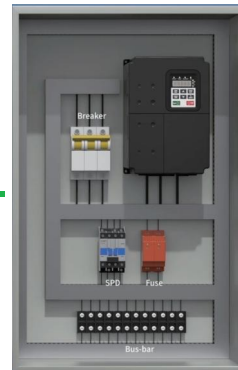

Traditional inverter

High Ingress Protection Degree

- Dust and waterproof: Prevent equipment failures caused by dust and moisture.
- Flexible installation: Can be directly installed below the PV modules.



High Reliability

- High safety: Support physical anti-theft.
- Significantly reduce damage rate caused by moisture, dust, and insects.

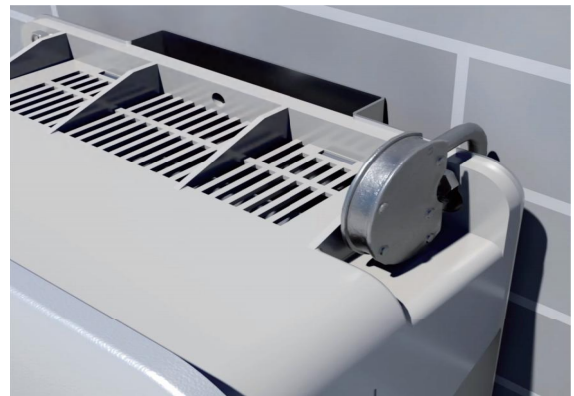



Max. DC input 900V

- Higher efficient .
- Start earlier and stop later.

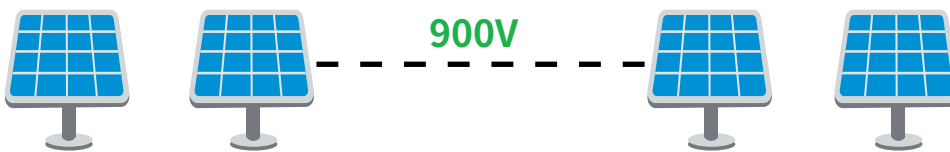

Built-in Booster

- Below 4kw SP100 integrate booster(include 4kw).
- The booster makes the inverter to start at low voltage, reducing the number of solar panels.

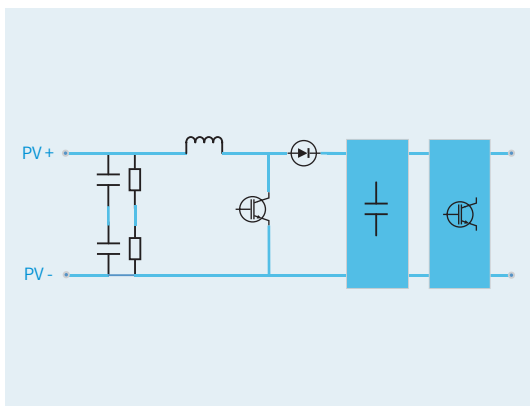

Efficient MPPT algorithm

- Integrated efficient MPPT algorithm for higher energy utilization and larger water discharge.

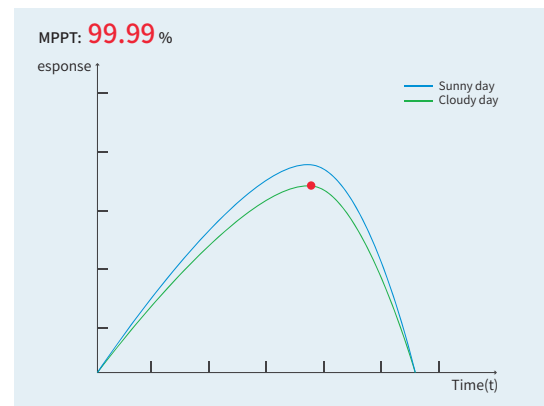



AC Working Mode

Hybrid mode

In hybrid mode, SP100 will use the energy of both PV modules and grid (or generator) at same time. The stronger the light radiation, the less AC energy is consumed. As the radiation reduction, the consumption of AC energy will increase to maintain the output.

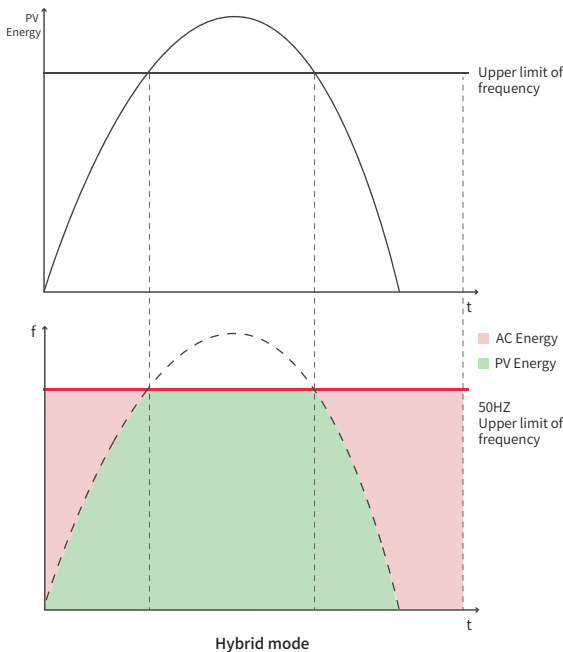

Auto-switching

If don't need to run at full high frequency at all times, SP100 has auto-switching function. It can monitor the PV voltage, and when the voltage is below the set threshold, it can control the contactor to act and connect AC power to meet energy needs. When the voltage on the PV side exceeds the set threshold, the contactor can be controlled to operate and disconnect the AC power to reduce energy consumption.

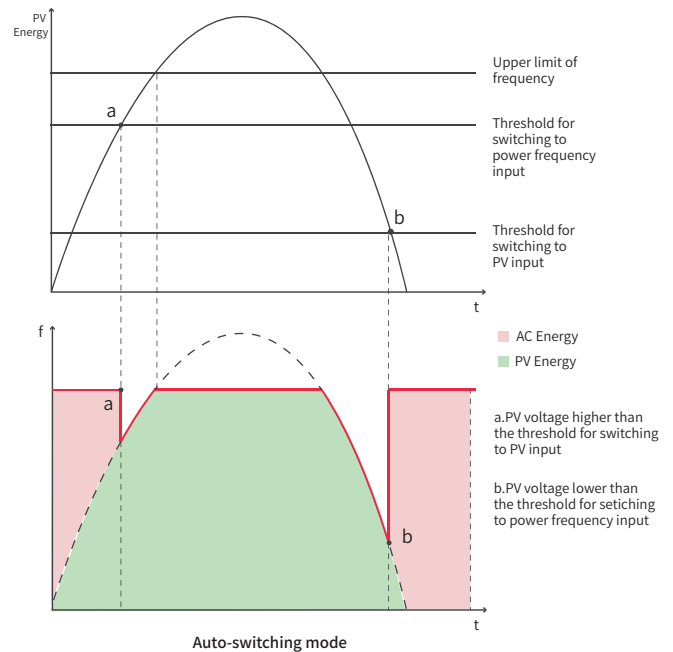

IOT

LCD screen

- Richer information display.

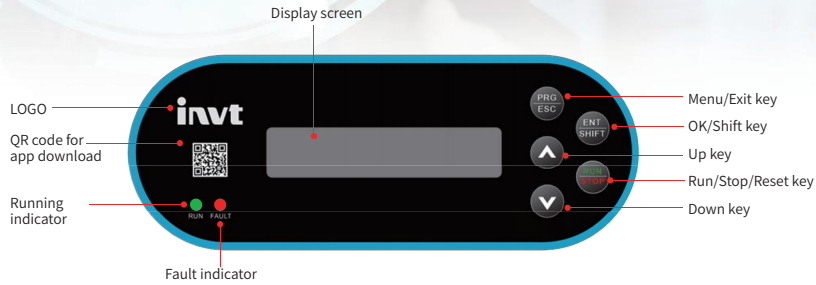

Remote monitoring

- Supports 4G and WiFi modules.
- Users can remotely monitor the solar water pump system through computers and mobile phones.

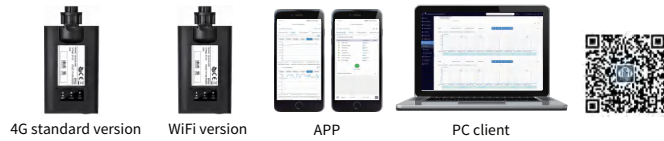

Remote upgrade

After-sales management

Fault per-alarm

Remote monitoring

Historic data query

Data analysis statistics

Model	ICA400-06N	ICA100-06N
Remote Communication Interface	4G	WIFI
Antenna	Built in	
Data Interface	RS485	
Working Voltage	DC5~12V	
Working Power	3W	1.5W
SIM Card	MicroSIM	-
Memory	8M Flash	2M Flash
Working Temperature	-25~65° C	
Working Humidity	<90% ((No Condensation)	
Shell material	PC+ABS VO	
Serial Communication Rate	9600bps (1200~115200 adjustable)	
Data Acquisition Interval	5 minutes (1~15 minutes adjustable)	
User Configuration	APP/Bluetooth	
Firmware Upgrade	Remote	

Rated specification parameters

Model	-D2	-D4	-2-T	-2	-4-T	-4
DC Input						
Max. Input Voltage(V)	450	900	450		900	
Start-up Voltage(V)	200	300	100	200	100	300
Min. Input Voltage(V)	150	250	70	150	70	250
Recommended Voltage Range(V)	200-400	300-850	100-400	200-400	100-850	300-850
Recommended MPP Voltage(V)	350	570	×	350	×	570
Booster module	×	×	Integrated	×	Integrated	×
MPPT Efficiency	99%					
AC Input						
Input voltage(V)	/		220V(-15%)~240V(+10%)		380V(-15%)~440V(+10%)	
AC Output						
Rated Output Voltage(V)	220	380	220		380	
Output Frequency Range(Hz)	0~400Hz					
Protection						
Low-voltage Protection	Integrated					
Over-voltage Protection	Integrated					
Over-load Protection	Integrated					
Dry Run Protection (Low-load protection)	Integrated					
Over-heat Protection	Integrated					
Surge Protection	Integrated					
Full-Water/Empty-Water	Integrated					
General Data						
Ingress Protection Degree	IP66					
Installation manner	Wall mounting					
GPRS	4G,WIFI					
Keypad	LCD					
Cooling manner	Nature cooling/ Fan cooling					

Product specifications

Series	Model	Input Voltage (V)	Rated output power(kW)	AC input current(A)	PV max current(A)	Output current(A)
DC	SP100-2R2-D2-6-S	DC 150~450V	2.2	/	15	5.5
	SP100-2R2-D4-6-S	DC 250~900V	2.2		15	5
	SP100-004-D4-6-S		4		15	9.5
	SP100-SRS-D4-6-S		5.5		30	14
	SP100-7R5-D4-6-S		7.5		30	18.5
	SP100-011-D4-6-S		11		30	25
	SP100-015-D4-6-S		15		45	32
	SP100-018-D4-6-S		18.5		45	38
	SP100-022-D4-6-S		22		45	45
AC&DC Built - in booster	SP100-0R7-2-T-6-S		AC 3PH/1PH 220 (-15%)~240(+10%) DC 100~450V	0.75	5(3PH)/9.3(1PH)	15
	SP100-1R5-2-T-6-S	1.5		7.7(3PH)/15.7(1PH)	15	7.5(3PH)/10.2(1PH)
	SP100-2R2-2-T-6-S	2.2		11(3PH)/24(1PH)	15	10(3PH)/14(1PH)
	SP100-2R2-4-T-6-S	AC 3PH 380 (-15%)~440(+10%) DC 220~900V	2.2	5.8	15	5.5
	SP100-004-4-T-6-S	4	13.5	15	9.5	
AC&DC	SP100-2R2-2-6-S	AC 3PH/1PH 220 (-15%)~240(+10%) DC 150~450V	2.2	11(3PH)/24(1PH)	15	10(3PH)/14(1PH)
	SP100-2R2-4-6-S	AC 3PH 380 (-15%)~440(+10%) DC 250~900V	2.2	5.8	15	5.5
	SP100-004-4-6-S		4	13.5	15	9.5
	SP100-5R5-4-6-S		5.5	19.5	30	14
	SP100-7R5-4-6-S		7.5	25	30	18.5
	SP100-011-4-6-S		11	32	30	25
	SP100-015-4-6-S		15	40	45	32
	SP100-018-4-6-S		18.5	47	45	38
	SP100-022-4-6-S		22	51	45	45

Terminal Introduction

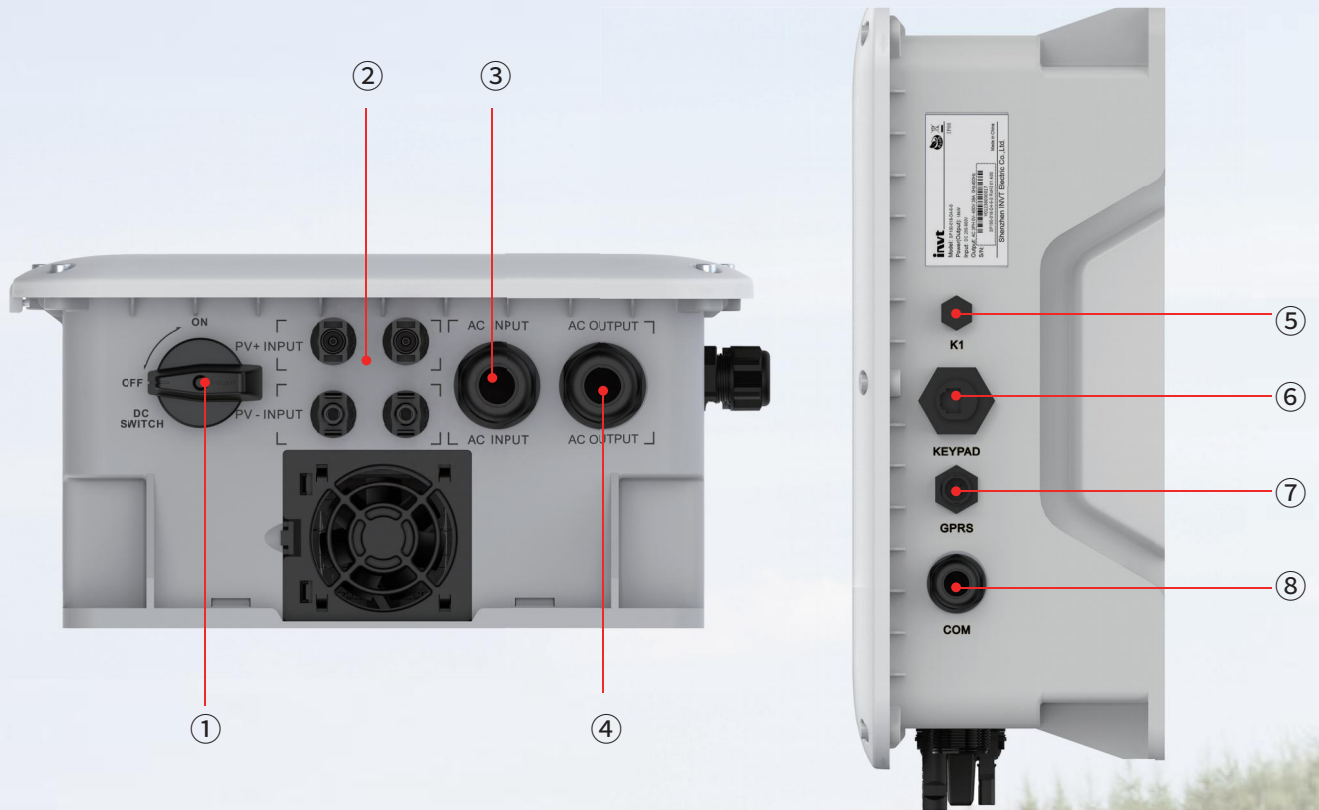

Sign	Description	Function
①	DC SWITCH	Control the on/off of DC input
②	PV INPUT	DC input terminals
③	AC INPUT	AC input terminal
④	AC OUTPUT	AC output terminal
⑤	K1	Air vent
⑥	KEYPAD	External keypad terminal
⑦	GPRS	IoT terminal
⑧	COM	Control signal terminal

Dimensions

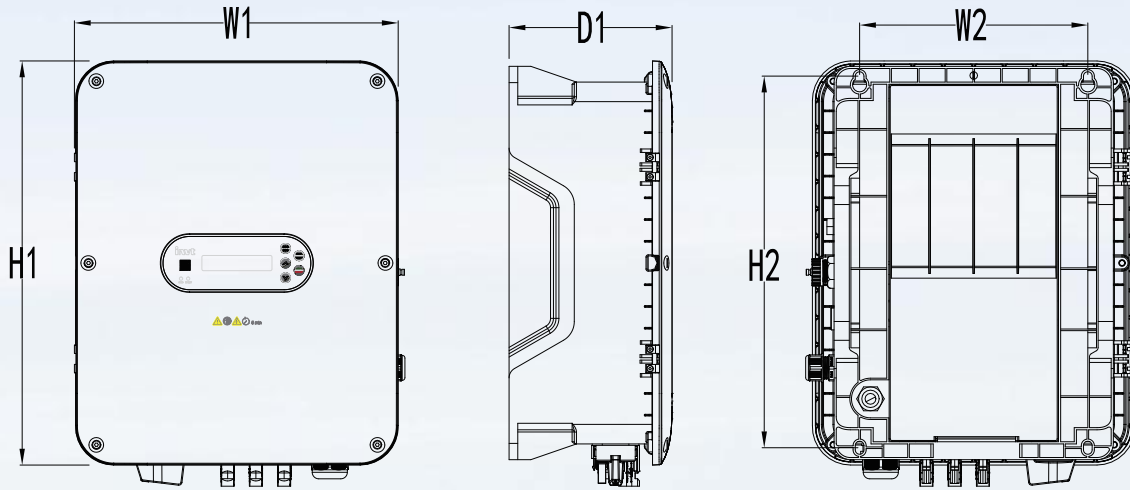

Feame	Model	Cooling manner	Dimension W×H×D(mm)	Weight (kg)
A1	SP100-2R2-D2-6-S	Nature Cooling	252×247×120	2
	SP100-2R2-D4-6-S	Nature Cooling		
	SP100-004-D4-6-S	Nature Cooling		
A2	SP100 - 5R5 - D4 - 6 - S	Nature Cooling	270×274×150	3.8
	SP100 - 7R5 - D4 - 6 - S	Nature Cooling		
	SP100 - 2R2 - 2 - 6 - S	Air Cooling		
	SP100 - 2R2 - 4 - 6 - S	Air Cooling		
A3	SP100 - 011 - D4 - 6 - S	Air Cooling	298×372×150	5
	SP100 - 015 - D4 - 6 - S	Air Cooling		
	SP100 - 018 - D4 - 6 - S	Air Cooling		
	SP100 - 0R7 - 2 - T - 6 - S	Air Cooling		
	SP100 - 1R5 - 2 - T - 6 - S	Air Cooling		
	SP100 - 2R2 - 2 - T - 6 - S	Air Cooling		
	SP100 - 2R2 - 4 - T - 6 - S	Air Cooling		
	SP100 - 004 - 4 - T - 6 - S	Air Cooling		
	SP100 - 004 - 4 - 6 - S	Air Cooling		
	SP100 - 5R5 - 4 - 6 - S	Air Cooling		
	SP100 - 7R5 - 4 - 6 - S	Air Cooling		
A4	SP100 - 011 - 4 - 6 - S	Air Cooling	481×390×211	11
	SP100 - 015 - 4 - 6 - S	Air Cooling		
	SP100 - 018 - 4 - 6 - S	Air Cooling		
	SP100 - 022 - 4 - 6 - S	Air Cooling		
	SP100 - 022 - D4 - 6 - S	Air Cooling		

Recommended Solar Array Configuration

Series	Model	Rated output power(kW)	Voc=49±1V P=540W
			Configuration
DC	SP100 - 2R2 - D2 - 6 - S	2.2	8*1
	SP100 - 2R2 - D4 - 6 - S	2.2	14*1
	SP100 - 004 - D4 - 6 - S	4	14*1
	SP100 - 5R5 - D4 - 6 - S	5.5	14*1
	SP100 - 7R5 - D4 - 6 - S	7.5	17*1
	SP100 - 011 - D4 - 6 - S	11	14*2
	SP100 - 015 - D4 - 6 - S	15	17*2
	SP100 - 018 - D4 - 6 - S	18.5	14*3
	SP100 - 022 - D4 - 6 - S	22	17*3
AC&DC Built-in booster	SP100 - 0R7 - 2 - T - 6 - S	0.75	2*1
	SP100 - 1R5 - 2 - T - 6 - S	1.5	4*1
	SP100 - 2R2 - 2 - T - 6 - S	2.2	5*1
	SP100 - 2R2 - 4 - T - 6 - S	2.2	5*1
	SP100 - 004 - 4 - T - 6 - S	4	9*1
AC&DC	SP100 - 2R2 - 4 - 6 - S	2.2	14*1
	SP100 - 004 - 4 - 6 - S	4	14*1
	SP100 - 5R5 - 4 - 6 - S	5.5	14*1
	SP100 - 7R5 - 4 - 6 - S	7.5	16*1
	SP100 - 011 - 4 - 6 - S	11	14*2
	SP100 - 015 - 4 - 6 - S	15	16*2
	SP100 - 018 - 4 - 6 - S	18.5	14*3
	SP100 - 022 - 4 - 6 - S	22	17*3

Marketing Service Network

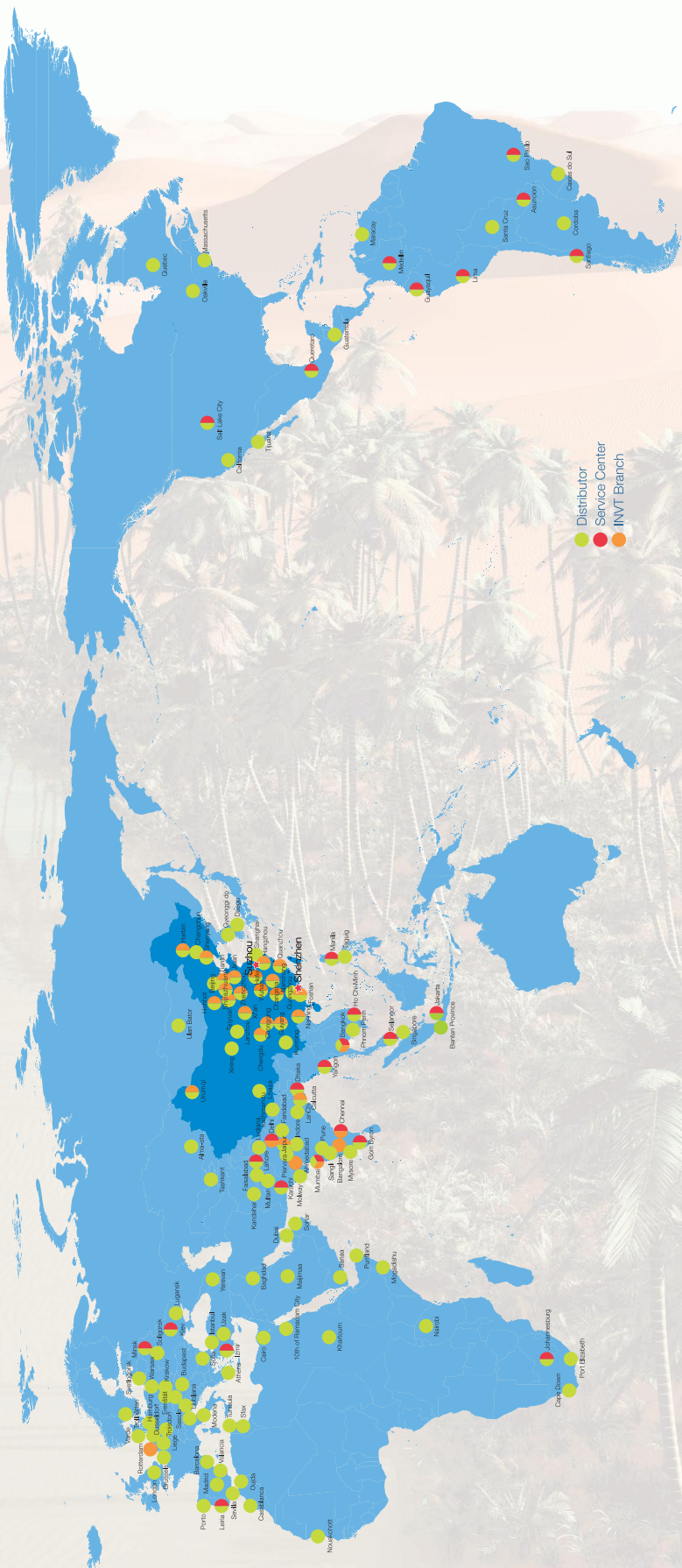

Your Trusted Industry Automation Solution Provider

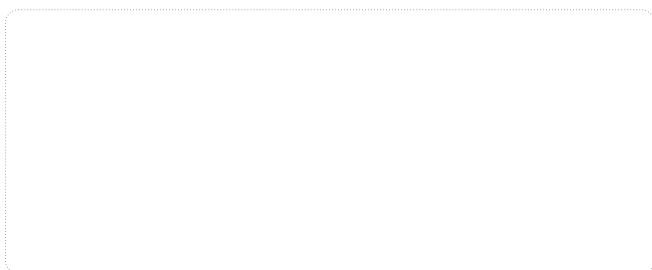

E-mail: overseas@invt.com.cn Website: www.invt.com

SHENZHEN INVT ELECTRIC CO.,LTD. INVT Guangming Technology Building, Songbai Road, Matian, Guangming District, Shenzhen, China

- Industrial Automation:**
- HMI
 - PLC
 - VFD
 - Servo System
 - Elevator Intelligent Control System
 - Rail Transit Traction System
- Electric Power:**
- UPS
 - DCIM
 - Solar Inverter
 - New Energy Vehicle Powertrain System
 - New Energy Vehicle Charging System
 - New Energy Vehicle Motor

INVT Copyright.
Information may be subject to change without notice during product improving.

66003-00356

202501 (V2.0)